

10-ohm 0.5%, 1%, 2%, 5% tolerance thick film current sense resistor

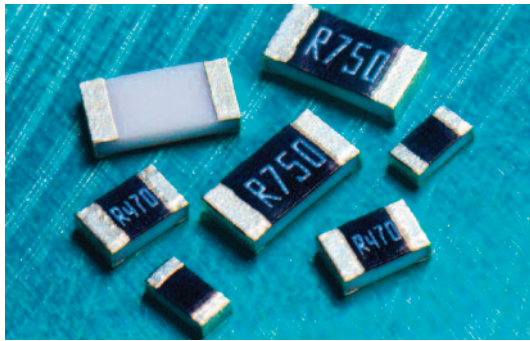

current sense



features

- Products with lead-free terminations meet EU RoHS requirements. EU RoHS regulation is not intended for Pb-glass contained in electrode, resistor element and glass.
- AEC-Q200 Qualified: 0402 (1E), 0603 (1J), 0805 (2A), 1206 (2B), 1210 (2E), 2010 (2H/W2H), 2512 (3A/W3A)

dimensions and construction

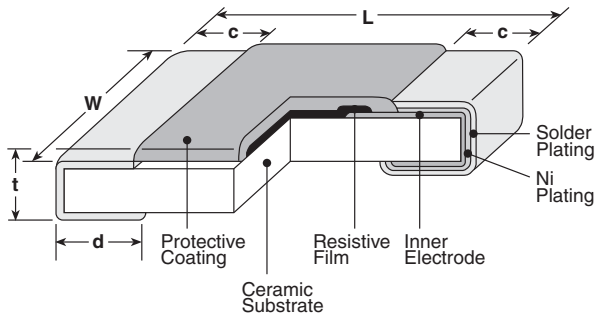

Type (Inch Size Code)	Dimensions inches (mm)				
	L	W	c	d	t
1H (0201)	.024±.001 (0.6±0.03)	.012±.001 (0.3±0.03)	.004±.002 (0.1±0.05)	.006±.002 (0.15±0.05)	.009±.001 (0.23±0.03)
1E (0402)	.039 ^{+0.004} _{-.002} (1.0 ^{+0.1} _{-0.05})	.02 ^{+0.004} _{-.002} (0.5 ^{+0.1} _{-0.05})	.01±.004 (0.25±0.1)	.01±.004 (0.25±0.1)	.014±.002 (0.35±0.05)
1J (0603)	.063±.008 (1.6±0.2)	.031 ^{+0.006} _{-.004} (0.8 ^{+0.15} _{-0.1})	.014±.004 (0.35±0.1)	.014±.004 (0.35±0.1)	.018±.004 (0.45±0.1)
2A (0805)	.079±.008 (2.0±0.2)	.049±.004 (1.25±0.1)	.016±.008 (0.4±0.2)	.012 ^{+0.008} _{-.004} (0.3 ^{+0.2} _{-0.1})	.02±.004 (0.5±0.1)
2B (1206)	.126±.008 (3.2±0.2)	.063±.008 (1.6±0.2)	.02±.012 (0.5±0.3)	.016 ^{+0.008} _{-.004} (0.4 ^{+0.2} _{-0.1})	.024±.004 (0.6±0.1)
2E (1210)		.102±.008 (2.6±0.2)			
2H (2010)	.197±.008 (5.0±0.2)	.098±.008 (2.5±0.2)			
W2H (2010)					
3A (2512)	.248±.008 (6.3±0.2)	.122±.008 (3.1±0.2)		.016 ^{+0.008} _{-.004} (0.4 ^{+0.2} _{-0.1})	
W3A (2512)				.026±.006 (0.65±0.15)	

ordering information

SR73	2B	T	TD	1R00	F
Type	Size	Termination Material	Packaging	Nominal Resistance	Tolerance
1H 1E 1J 2A 2B 2E W2H W3A 2H 3A	1H 1E 1J 2A 2B 2E W2H W3A 2H 3A	T: Sn L: SnPb (1E, 1J, 2A, 2B, 2E, 2H, 3A) G: Au (1J, 2A, 2B: 0.1Ω - 10Ω - contact factory)	TC: 0201 only: 7" 2mm pitch pressed paper (TC: 10,000 pcs/reel, TCM: 15,000 pcs/reel) TPL: 0402 only: 2mm pitch punch paper TP: 0402, 0603, 0805: 7" 2mm pitch punch paper TD: 0603, 0805, 1206, 1210: 7" 4mm pitch punched paper TE: 0805, 1206, 1210, 2010 & 2512: 7" embossed plastic For further information on packaging, please refer to Appendix A	±2%, ±5%: 2 significant figures + 1 multiplier "R" indicates decimal on value <10Ω ±1%: 3 significant figures + 1 multiplier "R" indicates decimal on value <100Ω All values less than 0.1Ω (100mΩ) are expressed in mΩ with "L" as decimal Example: 20mΩ = 20L (3-digit)	D: ±0.5% F: ±1% G: ±2% J: ±5%

applications and ratings

Part Designation*	Power Rating @ 70°C	Rated Ambient Temp.	Rated Terminal Part Temp.	T.C.R. (ppm/°C) Max.	Resistance Range			
					E-24, E-96 (D±0.5%)	E-24, E-96 (F±1%)**	E-24 (G±2%)	E-24 (J±5%)
SR731H (0201)	0.1W	70°C	—	0 ~ +400 0 ~ +500	—	1Ω - 10Ω**	—	0.27Ω - 10Ω 0.18Ω - 0.24Ω
SR731E (0402)	1/6W (.166W)	70°C	125°C	±200 ±300 ±500	— — —	0.51Ω - 10Ω** 0.2Ω - 0.47Ω** 0.1Ω - 0.18Ω**	0.51Ω - 10Ω 0.2Ω - 0.47Ω 0.1Ω - 0.18Ω	0.51Ω - 10Ω 0.2Ω - 0.47Ω 0.1Ω - 0.18Ω
SR731J (0603)	1/5W (.2W) New 1/4W (.25W)	70°C 70°C	125°C 125°C	±200	—	1.02Ω - 10Ω 0.1Ω - 1Ω	1.1Ω - 10Ω 0.1Ω - 1Ω	1.1Ω - 10Ω 0.1Ω - 1Ω

Specifications given herein may be changed at any time without prior notice. Please confirm technical specifications before you order and/or use.

12/01/19

10-ohm 0.5%, 1%, 2%, 5% tolerance thick film current sense resistor

applications and ratings (continued)

current sense

Part Designation*	Power Rating @ 70°C	Rated Ambient Temp.	Rated Terminal Part Temp.	T.C.R. (ppm/°C) Max.	Resistance Range				
					E-24, E-96 (D±0.5%)	E-24, E-96 (F±1%)**	E-24 (G±2%)	E-24 (J±5%)	
SR732A (0805)	1/3W (.33W)	70°C	125°C	±100	0.15Ω - 10Ω	0.1Ω - 10Ω	—	—	
				±200	—	—	0.1Ω - 10Ω	0.1Ω - 10Ω	
				±500	—	—	—	0.051Ω - 0.091Ω	
	1/2W (.5W) ¹	—	105°C	±100	0.15Ω - 10Ω	0.1Ω - 10Ω	—	—	
				±200	—	—	0.1Ω - 10Ω	0.1Ω - 10Ω	
				±500	—	—	—	0.051Ω - 0.091Ω	
SR732B (1206)	1/3W (.33W)	70°C	125°C	±100	0.15Ω - 10Ω	0.1Ω - 10Ω	—	—	
				±200	—	—	0.1Ω - 10Ω	0.1Ω - 10Ω	
				±500	—	—	—	0.056Ω - 0.091Ω	
	1/2W (.5W) ¹	—	110°C	±100	0.15Ω - 10Ω	0.1Ω - 10Ω	—	—	
				±200	—	—	0.1Ω - 10Ω	0.1Ω - 10Ω	
				±500	—	—	—	0.056Ω - 0.091Ω	
SR732E (1210)	1/2W (.5W)	70°C	125°C	±100	—	0.1Ω - 10Ω	—	—	
				±200	—	—	0.1Ω - 10Ω	0.047Ω - 10Ω	
				±500	—	—	—	0.036Ω - 0.043Ω	
	2/3W (.66W) ¹	—	110°C	±1000	—	—	—	0.024Ω - 0.033Ω	
				±100	—	0.1Ω - 10Ω	—	—	
				±200	—	—	0.1Ω - 10Ω	0.047Ω - 10Ω	
SR732H/W2H (2010)	3/4W (.75W)	70°C	125°C	±100	—	0.1Ω - 10Ω	—	—	
				±200	—	—	0.1Ω - 10Ω	0.1Ω - 10Ω	
				±500	—	—	—	0.056Ω - 0.091Ω	
	SR733A/W3A (2512)	1W	70°C	125°C	±100	—	0.1Ω - 10Ω	—	—
					±200	—	—	0.1Ω - 10Ω	0.1Ω - 10Ω
					±500	—	—	—	0.056Ω - 0.091Ω

* Parentheses indicate EIA package size codes. ** 1H, 1E (F: ±1%) E-24 values only. Operating Temp: -55°C to +125°C (SR731H only), -55°C to +150°C
 If any questions should arise whether to use the "Rated Ambient Temperature" or the "Rated Terminal Part Temperature," please give priority to the "Rated Terminal Part Temperature." Prior to use and for more details refer to "Introduction of the derating curves on the terminal part temperature" in the beginning of the catalog.
¹ Prior to use, refer to the "Higher Power Ratings" in the beginning of catalog. Rated voltage = √(Power rating x resistance value) or max. working voltage, whichever is lower

environmental applications

Derating Curve

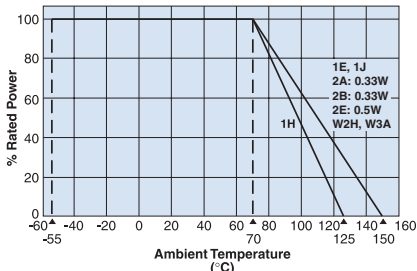

For resistors operated at an ambient temperature of 70°C or above, a power rating shall be derated in accordance with the derating curve.

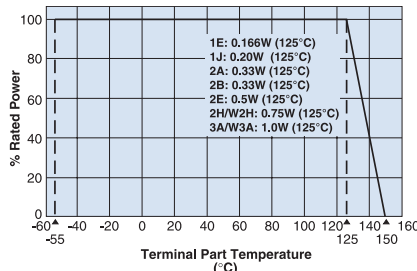

For resistors operated at a terminal part temperature of described for each size or above, a power rating shall be derated in accordance with the derating curve.

Please refer to "Introduction of the derating curve based on the terminal part temperature" on the beginning of our catalog before use.

SR73 2A (0.5W), SR73 2B (0.5W), SR73 2E (0.66W)

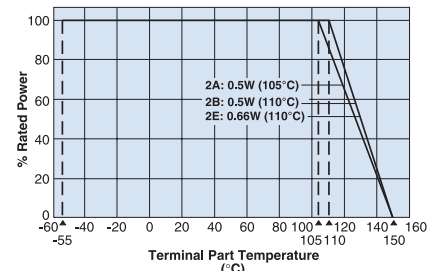

Temperature Rise

SR73 1E-1J

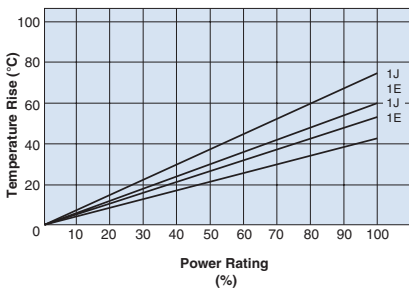

SR73 2A-2E

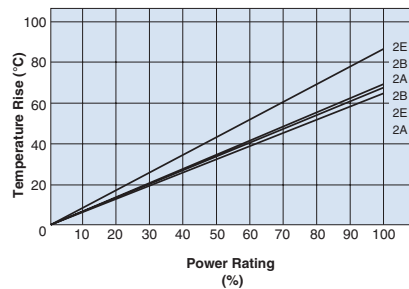

SR73 W2H

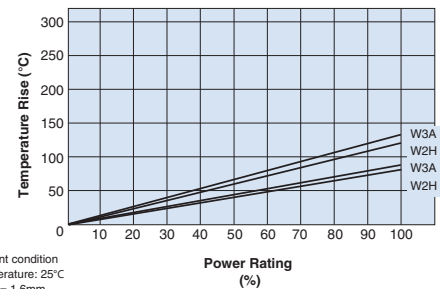

Measurement condition
 Room temperature: 25°C
 PCB: FR-4t = 1.6mm
 Cu foil thickness: 35µm

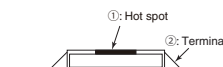

Regarding the temperature rise, the value of the temperature varies per conditions and board for use since the temperature is measured under our measuring conditions.

Specifications given herein may be changed at any time without prior notice. Please confirm technical specifications before you order and/or use.

12/11/19

One-Pulse Limiting Electric Power

SR73 1H-2A

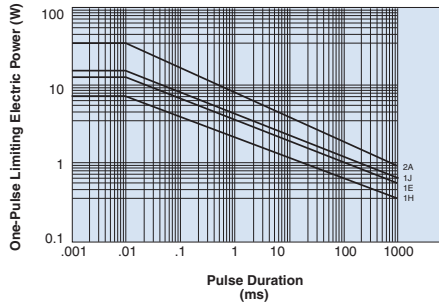

SR73 2B-W3A

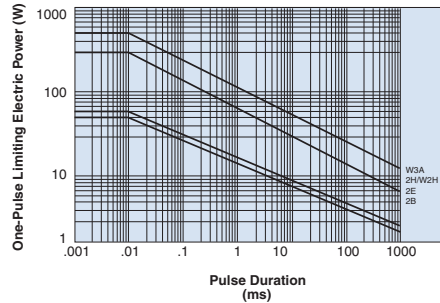

The maximum applicable voltage is equal to the max. overload voltage. Please contact factory for resistance characteristics of continuous applied pulse.

Performance Characteristics

Parameter	Requirement $\Delta R \pm(\%+0.005)$		Test Method
	Limit	Typical	
Resistance	Within specified tolerance	—	25°C
T.C.R.	Within specified T.C.R.	—	+25°C/-55°C and +25°C/+125°C
Overload (Short time)	$\pm 2\%$	$\pm 0.5\%$	Rated voltage x 2.5 for 5 seconds
Resistance to Solder Heat	1H: $\pm 3\%$, 1E-W3A: $\pm 1\%$	1H: $\pm 0.75\%$ 1E-W3A: $\pm 0.3\%$	260°C $\pm 5^\circ\text{C}$, 10 seconds ± 1 second
Rapid Change of Temperature	$\pm 1\%$	$\pm 0.3\%$	-40°C (30 minutes), +125°C (30 minutes), 100 cycles
Moisture Resistance	1H: $\pm 3\%$ 1E-W3A: $\pm 2\%$	$\pm 1\%$	40°C $\pm 2^\circ\text{C}$, 90%-95% RH, 1000 hours, 1.5 hr ON, 0.5 hr OFF cycle
Endurance at 70°C	1H: $\pm 3\%$ 1E-W3A: $\pm 2\%$	$\pm 1\%$	70°C $\pm 2^\circ\text{C}$, 1000 hours, 1.5 hr ON, 0.5 hr OFF cycle
High Temperature Exposure	$\pm 1\%$	$\pm 0.3\%$	1H: +125°C, 1000 hours; 1E, 1J, 2A, 2B, 2E, 2H/W2H, 3A/W3A: +150°C, 1000 hours